

gal[®] PLASTIC VALVES

DESCRIPTION

The direct-sealing diaphragm valves are operated by line pressure . The reinforced rubber diaphragm seals the water passage when line pressure reaches the valve's control chamber. Relieving the pressure from the control chamber, to the atmosphere or to downstream, causes the valve to open. The valve's only moving component is its diaphragm; no shaft, seals, or bearings are located within the water passage. The valve is made of sturdy, high-quality materials. It is produced in a number of structurally different versions (throttling, built-in solenoid operator, etc), with a wide range of control functions (manual activation, pressure control, etc).

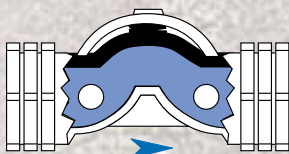

OPENED VALVE

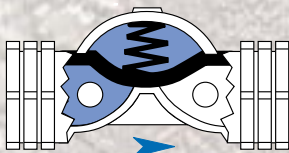

CLOSED VALVE

ADVANTAGES

- Structural simplicity
- Superb hydraulic performance
- Reliable control of corrosive liquids
- Light-weight, cost-saving
- Minimum maintenance - maximum dependability



MODEL 95



MODEL 96



MODEL 96-6



MODEL 75-1-E/D2



MODEL 75-2-T-E/D2

SIZE SELECTION GUIDE

This graph provides a guide, based on flow rate and pressure, for the proper selection of valve size.

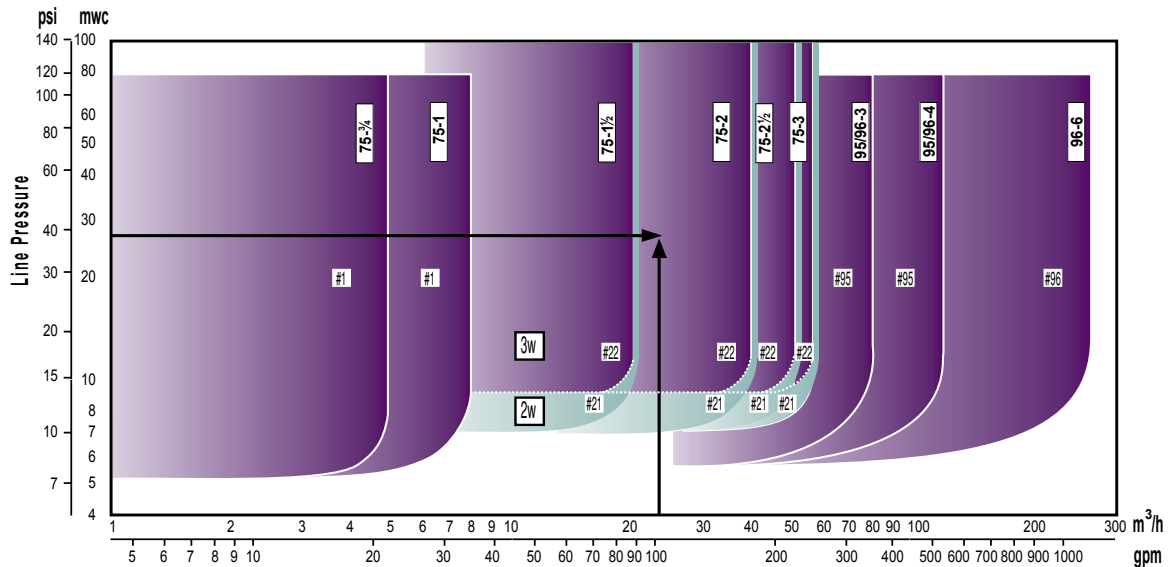

Locate the **flow rate** on the horizontal axis and draw a line upwards.
 Locate the **line pressure** on the vertical axis and draw a line to the right.
 The intersection point of the two lines marks the appropriate valve size.

Example: line pressure 28m (40 psi), flow rate 23 m³/h (100 gpm), appropriate valve = model 75-2"

PRINCIPLE OF OPERATION

1 3-WAY CONTROL

This control device admits pressure into the control chamber, closing the valve, or relieves pressure to the atmosphere, fully opens the valve.

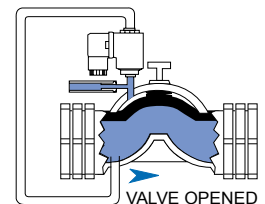
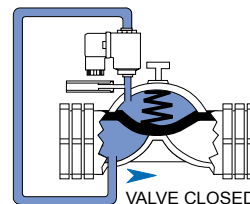

2 2-WAY ELECTRIC CONTROL

A solenoid operator plugs the control chamber outlet. A permanent connection from the upstream to the control chamber ensures line pressure in the chamber and thus valve closure. Energizing the solenoid operator causes the control chamber to drain to downstream, opening the valve.

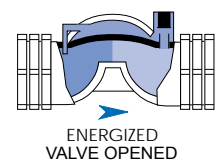
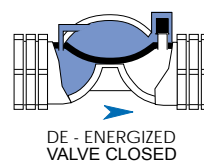

MODEL SELECTION TABLE

| MODEL | 75 | | | | | | | 95 | 96 | | |
|---|------------|-----------|---------|-------------|---------|-------------|---------|---------|---------|----------|----------|
| | GRP | | | | | | | uPVC | uPVC | | |
| CONNECTION | TH | | | | | | | TH | SW | | |
| SIZE | Inch mm | 3/4 20 | 1 25 | 1 1/2 40 | 2 50 | 2 1/2 65 | 3 80 | 3 80 | 3 90 | 4 110 | 6 160 |
| STRUCTURAL VERSION | CODE | | | | | | | | | | |
| BASIC | - | | | ● | ● | ● | ● | ● | ● | ● | ● |
| THROTTLING | T | | | ● | ● | ● | ● | | | | |
| INTEGRAL 2-WAY ELECTRIC CONTROL (DOROT SOLENOID) | E/D2 | ● | ● | ● | ● | ● | ● | | | | |
| INTEGRAL 3-WAY ELECTRIC CONTROL (GEMSOL SOLENOID) | E/B3 | | | ● | ● | ● | ● | | | | |
| THROTTLING + 2-WAY ELECTRIC CONTROL DOROT SOL. | T-E/D2 | ● | ● | ● | ● | ● | ● | | | | |
| THROTTLING + 3-WAY ELECTRIC CONTROL GEMSOL | T-E/B3 | | | ● | ● | ● | ● | | | | |

* Non - Integral Solenoid

ABBREVIATIONS: ● GRP = GLASS - REINFORCED POLYAMIDE ● uPVC = UNPLASTICIZED POLYVINYL CHLORIDE ● TH = THREADED ● SW = SOLVENT WELDED

* FOR NON-RETURN FEATURE, PLEASE ADD "N" - E/D2-N

HEADLOSS CHART

(BLUE AREA INDICATES RECCONENDED OPERATING RANGE)

3-WAY CONTROL MODEL 75, 95, 96

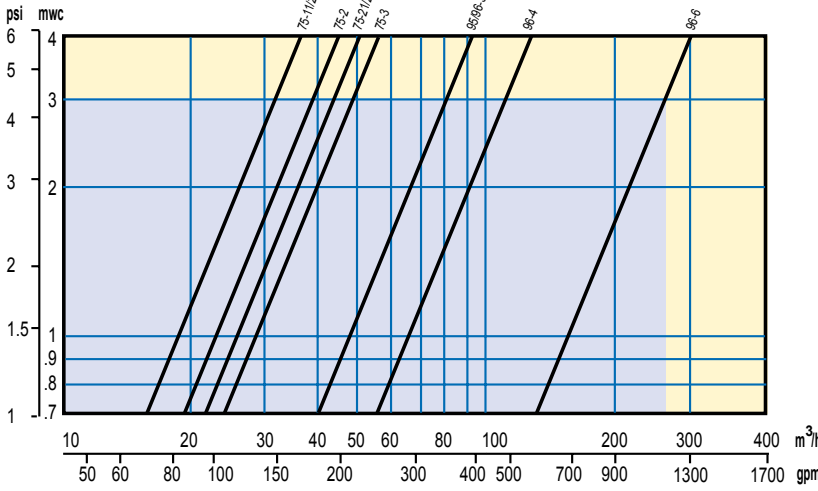

2-WAY ELECTRIC CONTROL-MODEL 75

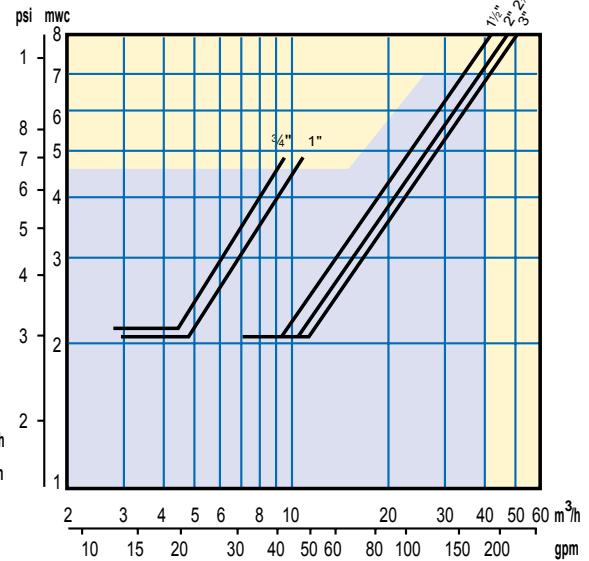

PRESSURE RATING

- MODEL 75 SIZES 3/4", 1" - 80 m (115 psi)
- MODEL 75 SIZES 1 1/2" - 3" - 100 m (145 psi)
- MODEL 95/96 SIZES 3", 4" - 80 m (115 psi)
- MODEL 96 SIZE 6" - 100 m (145 psi)

SPECIFICATIONS

MATERIALS

- VALVE: BODY ----- MODEL 75: 30% GLASS REINFORCED POLYAMIDE MODELS 95, 96: uPVC
- BONNET ----- 30% GLASS REINFORCED POLYAMIDE
- DIAPHRAGM ----- NATURAL RUBBER
- SPRING ----- SST 302
- SPRING SEAT ----- POLYAMIDE
- NUTS AND BOLTS --- COATED STEEL OR SST 304
- SOLENOID OPERATOR:
- COIL ----- POLYESTER-COATED STEEL
- PLUNGER ----- SST
- SEAL ----- BUNA-N OR NR

CONNECTIONS

- THREAD:
- FEMALE ISO (BSP), ANSI (NPT)
- SOLVENT WELDING:
- BS 4346.1/ASTM D2467/AS 1477
- ISO 727, DIN 8063.

ELECTRICAL DATA

- 8 WATT OPERATOR: VOLTAGE 24VAC 50HZ, OTHERS ON REQUEST
INRUSH CURRENT 1.1A, HOLDING 0.66A
- 3 WATT OPERATOR: VOLTAGE 24VAC, 50HZ/60HZ, OTHERS ON REQUEST
INRUSH CURRENT 0.3 A, HOLDING 0.15A
- NOTE: THE STANDARD COIL IS 24 VAC, 50HZ. OTHERS ON REQUEST

THE FACTORY RESERVES THE RIGHT TO MODIFY SPECIFICATIONS WITHOUT PRIOR NOTICE.

DIMENSIONS

| MODEL | SIZE | | L | | H | |
|-------|-------|-----|-----|--------|-----|-------|
| | Inch | mm | mm | Inch | mm | Inch |
| 75 | 3/4 | 20 | 113 | 4 1/2 | 70 | 2 3/4 |
| 75 | 1 | 25 | 124 | 4 7/8 | 73 | 2 7/8 |
| 75 | 1 1/2 | 40 | 188 | 7 3/8 | 110 | 4 3/8 |
| 75 | 2 | 50 | 199 | 7 7/8 | 110 | 4 3/8 |
| 75 | 2 1/2 | 65 | 228 | 9 | 119 | 4 5/8 |
| 75 | 3 | 80 | 236 | 9 1/4 | 120 | 4 3/4 |
| 95/96 | 3 | 80 | 258 | 10 1/8 | 195 | 7 5/8 |
| 96 | 4 | 110 | 278 | 11 | 202 | 8 |
| 96 | 6 | 160 | 360 | 14 | 380 | 15 |

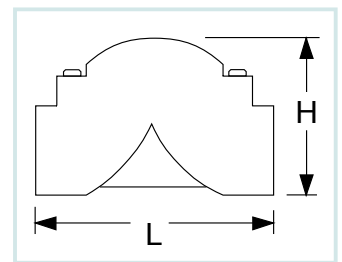

COMPONENTS

Specify **model code** and **size** when ordering spare parts. Example: **Part no. 4** for **75 - 2 - E/D2**

DESCRIPTION 75-2WAY

- 1 LONG BOLT
- 2 SHORT BOLT
- 3 2-WAY BONNET
- 4 2-WAY DIAPHRAGM
- 5 BODY
- 6 2-WAY OPTIONAL THROTTLING
- 7 THROTTLING DISC
- 8 MANUAL ACTIVATION RING
- 9 ADAPTOR
- 10 O-RING
- 11 O-RING
- 12 INLET FILTER
- 13 2 Watt OPERATOR (2-WAY)
- 14 PLUG
- 15 NUT

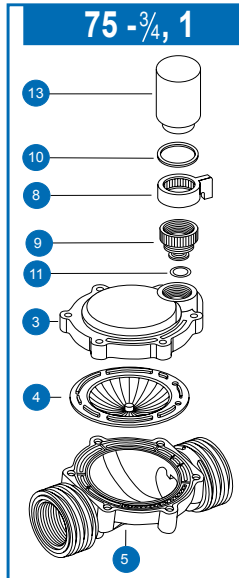
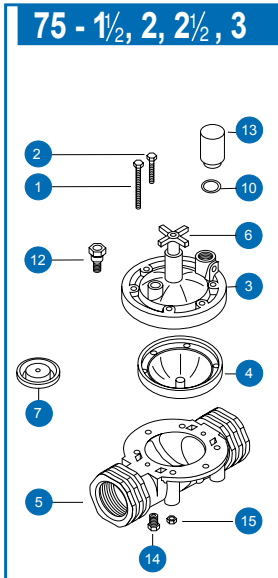

DESCRIPTION 75-3WAY

- 1 LONG BOLT
- 2 SHORT BOLT
- 3 SPRING
- 4 3-WAY DIAPHRAGM
- 5 BODY
- 6 3-WAY OPTIONAL THROTTLING
- 7 THROTTLING DISC
- 8 O-RING
- 9 8 Watt OPERATOR (3-WAY)
- 10 FINGER FILTER
- 11 NUT
- 12 3-WAY CONTROL VALVE ADAPTOR

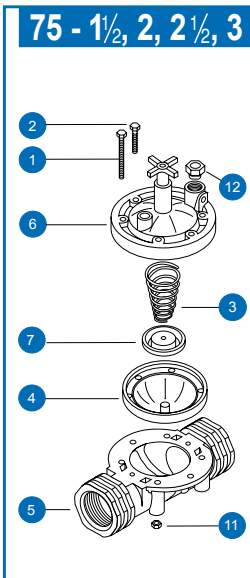
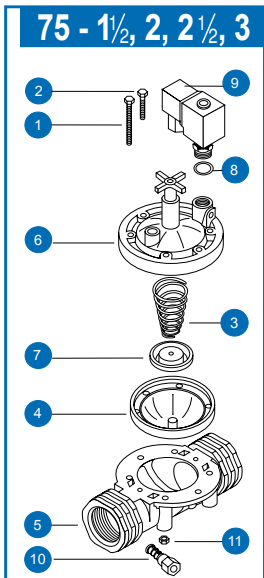

DESCRIPTION 95, 96

- 1 LONG BOLT
- 2 SHORT BOLT
- 3 WASHER
- 4 BONNET
- 5 SPRING
- 6 SPRING SEAT
- 7 DIAPHRAGM
- 8 BODY
- 9 NUT
- 10 FINGER FILTER

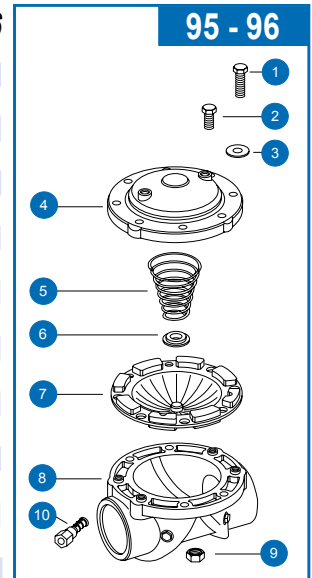

ORDERING GUIDE

- 1 Select valve size, using the "size selection" graph located on page 9.
- 2 Select valve model, using table on page 10.

Example: selected, is a 2" valve, made of glass-reinforced polyamide, controlled by a 2-way solenoid operator.

SPECIFY:

- **MODEL**
75,95,96
- **SIZE**
1/4", 1", 1 1/2", 2", 2 1/2", 3", 4", 6"
80mm, 90mm, 110mm, 160mm
- **CONNECTION STANDARD**
(THREADED MODELS ONLY) NPT, BSP
- **STRUCTURAL VERSION (WHEN APPLICABLE)**
T, E/D2, E/B3, T-E/D2, T-E/B3

75 - 2 - BSP - E/D2

FOR OTHER CONTROL FUNCTIONS REFER TO SECTION F.